

# UP1

## All-in-Two Solar Street Light



IP65	IK07(PV)	IK08	CE
------	----------	------	----



LIGHTING	LED module	High efficiency LED light engine - Multichip Technology (IP 67)
	Luminous flux	1,600 to 2,800 lumens*
	Consumption	10 W to 20 W*
	Lighting efficiency	Up to 164 lm/W
	Color temperature options	3000K, 4000K or 5700K
	Lifespan	100,000 hours certified by IESNA LM-90 B-50
	Certificates	EN 13032-1; EN 13032-2; EN 13201; EN 60598-1; EN 62471
SOLAR PANEL	Technology	Photovoltaic module (Monocrystalline silicon)
	Power	50 Wp
	Electrical characteristics (per panel)	VOC : 22,89 V / VMPP : 18,54 V / ISC : 2,85A / IMPP : 2,7A / 36 cells
	Dimensions (per panel)	40 x 14 inches (1000 x 350 mm)
	Lifespan	25 years
	Tilt	25° / 50°
	Structure	Frameless
Certificates	IEC 61215; IEC 61730 I and II	
BATTERY	Battery technology	NiMH battery, maintenance free, very high temperature resistance
	Voltage	12V
	Capacity	120 Wh
	Operating temperature range	-40°F to +158°F (-40°C to +70°C)
	Lifespan	12 years
	Certificates	EN 62133
ELECTRONICS	Technology	SunnaCore®
	Communication	Bluetooth
	Input voltage	12V
	Max. PV open circuit voltage	22,5V
	Max. charge/discharge current	5A
	Wiring	Marine-grade wiring used for all applications
	Electrical protection	Electronic fuse
	Lifespan	12 years
	Water resistance	IP65 with sealed plugs
	Operating temperature range	-4°F to +158°F (-20°C to +70°C)
	Certificates	CE; EN61000; EN61547; EN55015; EN62493; EN 62479 EN300328; EN 301489-1
GENERAL	Material	ABS PMMA casing (100% recycled) and aluminum
	EPA	4.30 ft <sup>2</sup> (0.40 m <sup>2</sup> )
	Fixation	Solar engine: Top mounting Ø2.38 inches (Ø60 mm), Fixture: horizontal bracket
	Weight (without pole)	29 lbs (13 kg)
	Options*	Motion sensor Anti-theft screws
Smart Lighting options	Smart Lighting and Detection Remote monitoring	

\* Options on demand

## Dimensions

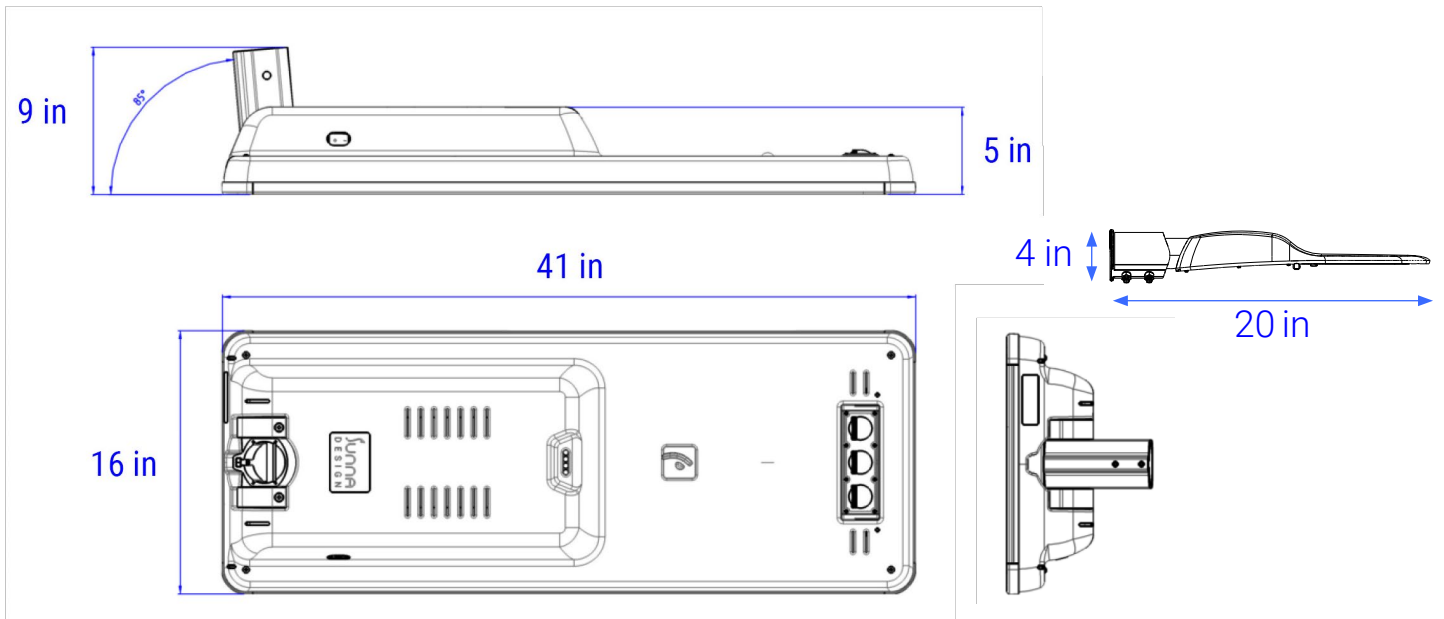

## Available colors



RAL 9010



RAL 8019

## Light distribution

NARROW ROAD

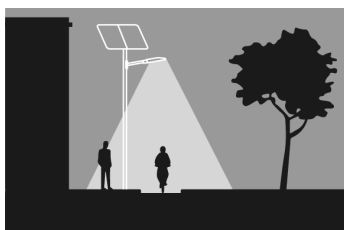
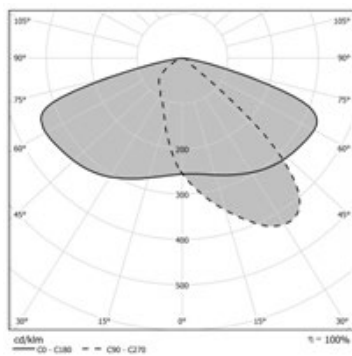

MEDIUM ROAD

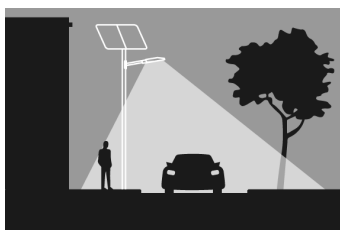
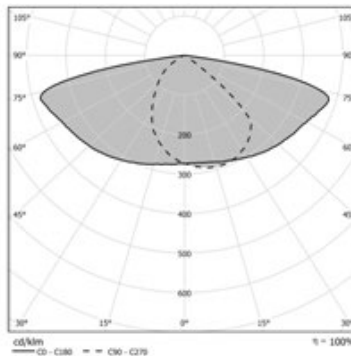

AREA WIDE ROAD

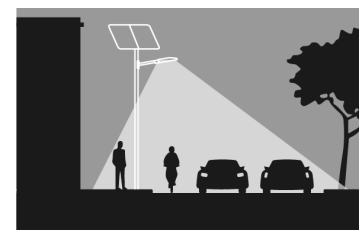
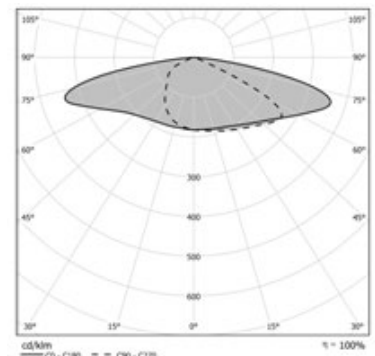

## References

PRODUCT REFERENCE	PRODUCT DESCRIPTION
SL4140 00 0000	UP1
SL4140 10 0000	UP1 - motion sensor