

# UP2

## All-in-Two Solar Street Light



IP65	IK07(PV)	IK08	CE
------	----------	------	----



LIGHTING	LED module	High efficiency LED light engine - Multichip Technology (IP 67)
	Luminous flux	3,200 to 5,600 lumens*
	Consumption	20 W to 40 W*
	Lighting efficiency	Up to 164 lm/W
	Color temperature options	3000K, 4000K or 5700K
	Lifespan	100,000 hours certified by IESNA LM-90 B-50
	Certificates	EN 13032-1; EN 13032-2; EN 13201; EN 60598-1; EN 62471
SOLAR PANEL	Technology	Photovoltaic module (Monocrystalline silicon)
	Power	80 Wp (2x40 Wp)
	Electrical characteristics (per panel)	VOC : 23,4 V / VMPP : 18,72 V / ISC : 2,34 A / IMPP : 2,14 A / 36 cells
	Dimensions (per panel)	30 x 14 inches (776 x 350 mm)
	Lifespan	25 years
	Tilt	10° / 25° / 40° / 50°
	Structure	Frameless
BATTERY	Certificates	IEC 61215; IEC 61730 I and II
	Battery technology	NiMH battery, maintenance free, very high temperature resistance
	Voltage	24V
	Capacity	240 Wh
	Operating temperature range	-40°F to +158°F (-40°C to +70°C)
	Lifespan	12 years
	Certificates	EN 62133
ELECTRONICS	Technology	SunnaCore®
	Communication	Bluetooth
	Input voltage	24V
	Max. PV open circuit voltage	45V
	Max. charge/discharge current	5A
	Wiring	Marine-grade wiring used for all applications
	Electrical protection	Electronic fuse
	Lifespan	12 years
	Water resistance	IP65 with sealed plugs
	Operating temperature range	-4°F to +158°F (-20°C to +70°C)
GENERAL	Certificates	CE; EN61000; EN61547; EN55015; EN62493; EN 62479 EN300328; EN 301489-1
	Material	ABS PMMA casing (100% recycled) and aluminum
	EPA	6.67 ft <sup>2</sup> (0.62 m <sup>2</sup> )
	Fixation	Solar engine: Top mounting Ø60 mm ; Lantern: horizontal bracket
	Weight (without pole)	51 lbs (23 kg)
	Options	Motion sensor Anti-theft screws Anti birds spikes
	Smart Ligting options	Smart Lighting and Detection Remote monitoring

\* Available with motion sensor

## Dimensions

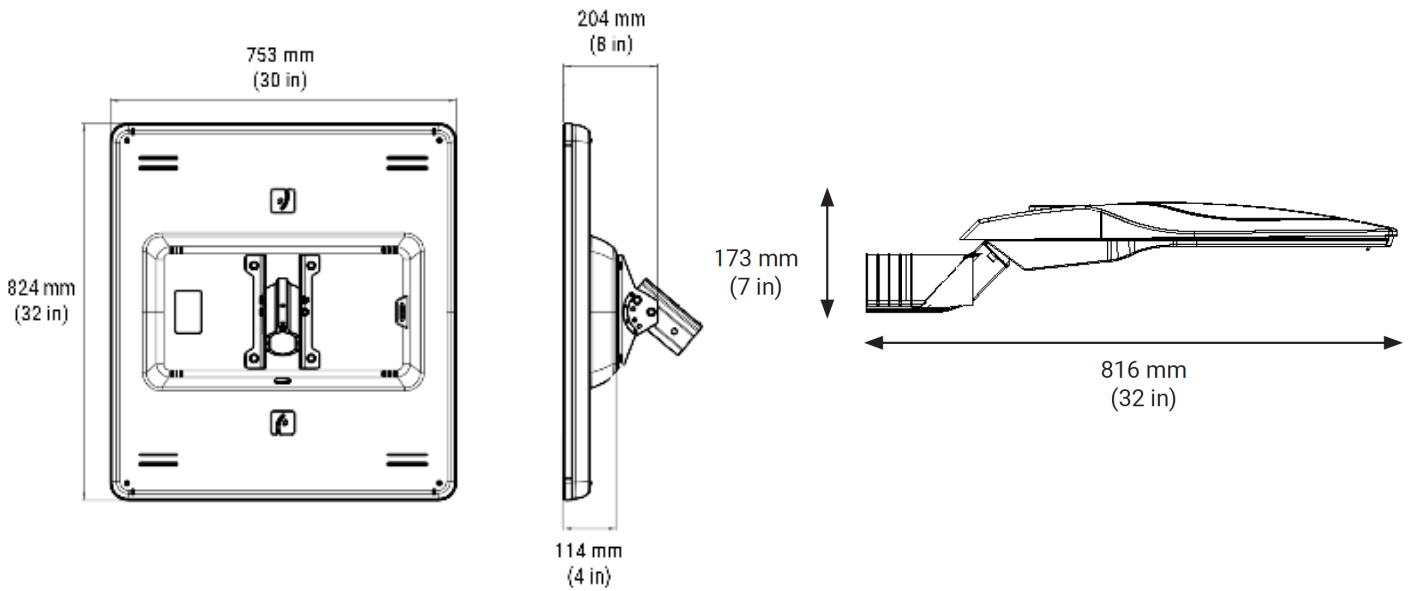

## Available colors

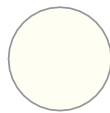

RAL 9010



RAL 8019

## Light distribution

NARROW ROAD

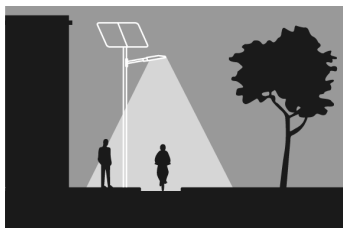
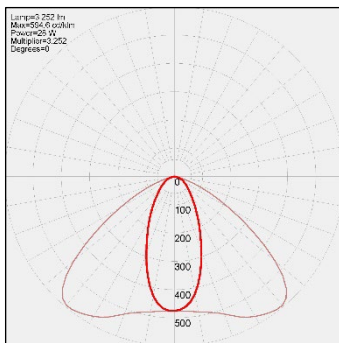

MEDIUM ROAD

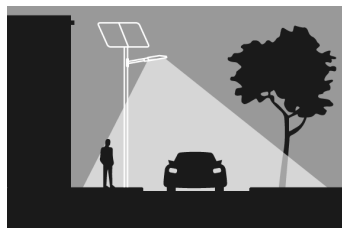
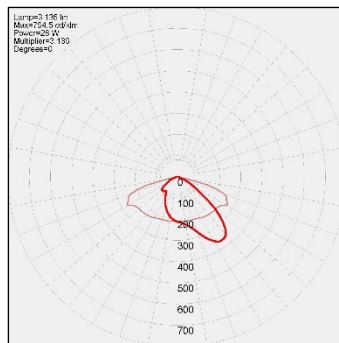

AREA WIDE ROAD

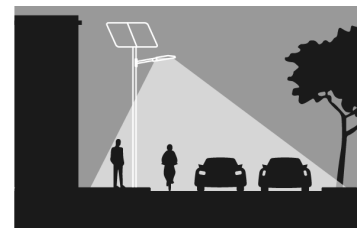
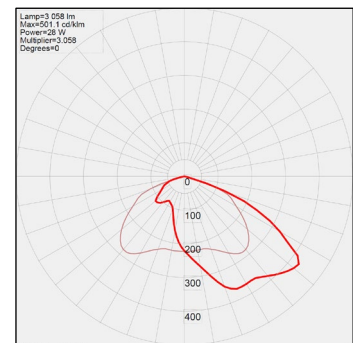

## References

PRODUCT REFERENCE	PRODUCT DESCRIPTION
SL4249 00 0000	UP2
SL4249 10 0000	UP2 - motion sensor