

UP1

Solar streetlight

IP65

IK07(PV)

IK08

CE

Sol[®]
by Sunna Design[®]

6

YEARS
WARRANTY



LIGHTING	LED module	High efficiency LED light engine - Multichip Technology (IP 67)
	Luminous flux	1,600 to 2,800 lumens*
	Consumption	10 W to 20 W*
	Lighting efficiency	Up to 164 lm/W
	Color temperature options	3000 K, 4000 K & 5700 K
	Lifespan	100,000 hours certified by IESNA LM-90 B-50
	Certificates	EN 13032-1; EN 13032-2; EN 13201; EN 60598-1; EN 62471
SOLAR PANEL	Technology	Photovoltaic module (Monocrystalline silicon)
	Power	50 Wp
	Electrical characteristics (per panel)	VOC : 22,89 V / VMPP : 18,54 V / ISC : 2,85A / IMPP : 2,7A / 36 cells
	Dimensions (per panel)	39,4 x 13,8 inches (1000x350mm)
	Lifespan	25 years
	Tilt	5° / 25° / 50°
	Structure	Frameless
BATTERY	Certificates	IEC 61215; IEC 61730 I and II
	Battery technology	NIMH battery, maintenance free, very high temperature resistance
	Voltage	12V
	Capacity	120 Wh
	Operating temperature range	-40°C to +70°C (-40°F to +158°F)
	Lifespan	12 years
ELECTRONICS	Certificates	EN 62133
	Technology	SunnaCore®
	Communication	Bluetooth
	Input voltage	12V
	Max. PV open circuit voltage	22,5V
	Max. charge/discharge current	5A
	Wiring	Marine-grade wiring used for all applications
	Electrical protection	Electronic fuse
	Lifespan	12 years
	Water resistance	IP65 with sealed plugs
	Operating temperature range	-20°C to +70°C (-4°F to +158°F)
GENERAL	Certificates	CE; EN61000; EN61547; EN55015; EN62493; EN 62479 EN300328; EN 301489-1
	Material	ABS PMMA casing (100% recycled) and aluminum
	EPA	4,30 ft² (0,4m²)
	Fixation	Solar engine: Top mounting Outside Diameter : 2,38 inches (60mm), Lantern: horizontal bracket
	Weight (without pole)	29 lbs
	Options*	Motion sensor / Anti-theft screws
Smart Ligting options	Smart Lighting and Detection / Remote monitoring	

Dimensions

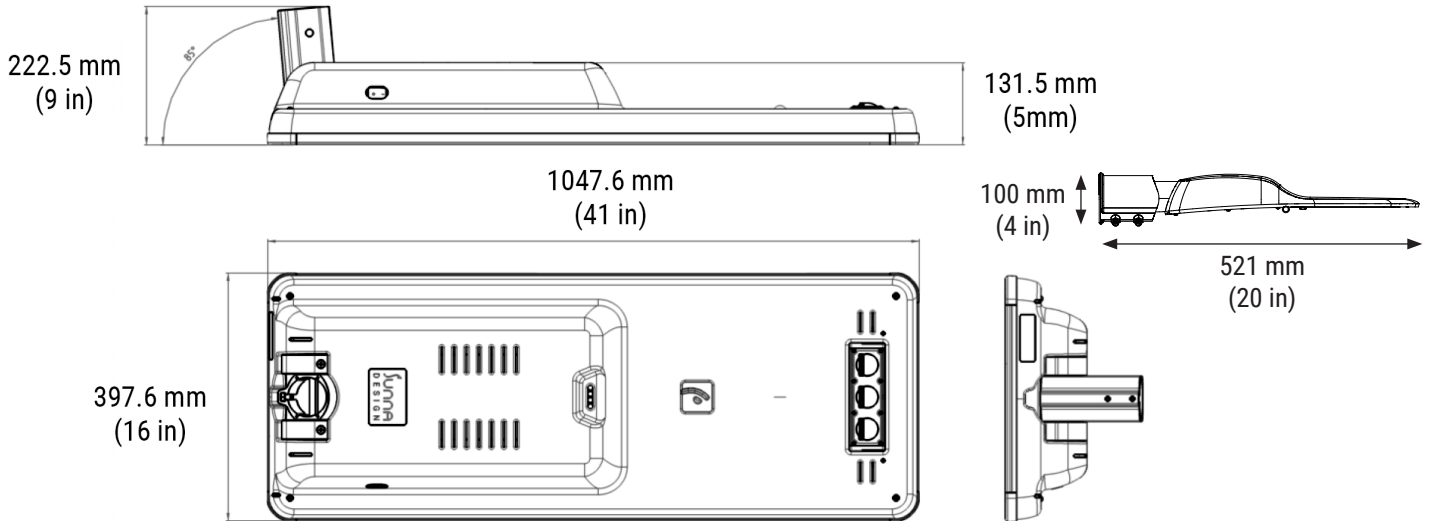

Available colors



RAL 9010



RAL 8019

Light distribution

NARROW ROAD

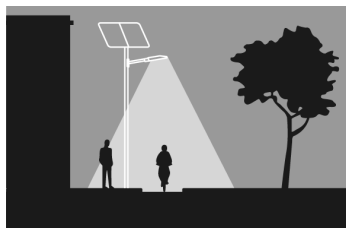
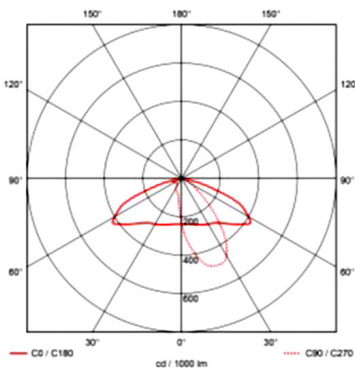

MEDIUM ROAD

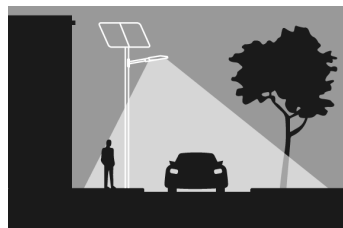
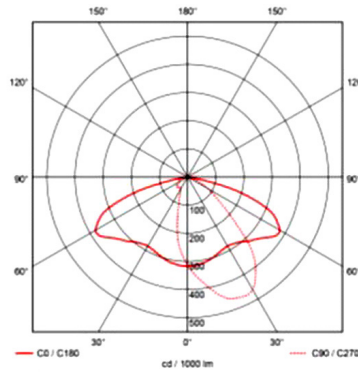

AREA & WIDE ROAD

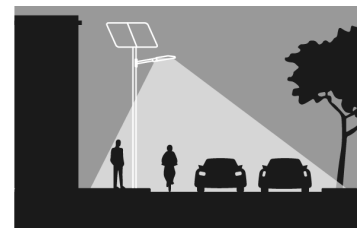
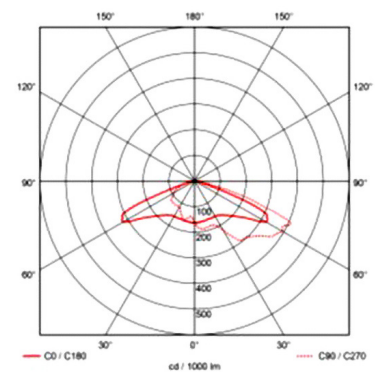

References

PRODUCT REFERENCE	PRODUCT DESCRIPTION
SD4140 000 000	UP1
SD4140 100 000	UP1 - motion sensor